



Product description

The Tannoy AMS 8DC is a wide bandwidth, high power-handling and high sensitivity surface mount loudspeaker designed with an aesthetic that is perfect for the architectural considerations of building design. The elegantly styled moulded enclosures blend beautifully into any décor with custom colour available on special order. Additionally the AMS 8DC has undergone the most punishing environmental testing of any product in Tannoy's history – achieving an IP65 rating, which is among the highest in the industry for outdoor use.

Behind the unobtrusive, smoothly formed, weather-resistant zinc-plated nickel grilles and higher temperature polymer mouldings lies the technical heart of Tannoy's Dual Concentric Driver's revolutionary Omnimagnet™ technology and a unique patent-pending Torus Ogive Waveguide™ device. Together these innovations provide more consistent and controlled directivity along with improved high frequency response, as well as much improved time alignment and greater coherence between the low frequency and high frequency drivers.

This latest generation of Dual Concentrics have their genesis in many of the world's high end recording studios, with that classic signature Tannoy technology being used to mix and master a rich history of recording industry classics, including The Beatles' most treasured recordings in London's Abbey Road. By extension, the new AMS models ensure that playback of recorded material sounds exactly as the engineer intended when it was mixed in the studio, making them perfect for entertainment and hospitality venues, as well as areas where true sonic clarity and reliability is required.

The AMS range utilises a 16 ohm driver, making it ideal for use in high performance low-impedance systems (with optimized performance when used in conjunction with Lab.gruppen LUCIA amplifiers). Alternatively, for constant voltage systems, Tannoy have specified as standard, high quality low-insertion loss 60 W transformers featuring switching for taps at 60 W, 30 W and 15 W, with an additional 7.5 W tap for traditional systems.

Features

- Next-generation Dual Concentric driver featuring Omnimagnet technology
- Torus Ogive waveguide for improved broadband directivity
- 16-ohm drivers optimized for use with Lab.gruppen LUCIA amplifiers
- Yoke bracket included; optional any-angle accessory bracket available
- Weather resistant rated IP65 to EN60529 (IEC529)
- Thickened 5 mm high-temperature molded cabinets
- Custom color options

Applications

- Multi-zone foreground music and paging
- Boardrooms, offices and courtrooms
- Business music systems
- Airports, convention centres and hotels
- Auxiliary systems in houses of worship
- Lounges and bars
- Cruise ships

Physical data

Dimensions (H x W x D):	409.8 x 260.0 x 306.3 mm, (16.13 x 10.24 x 12.06")
Net Weight:	7.82 kg (17.24 lbs)
Enclosure:	ABS
Finish:	Black or white

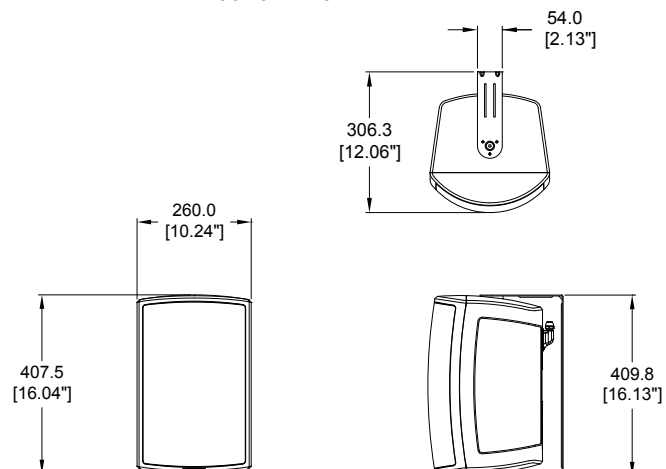

1 m on-axis Frequency Response

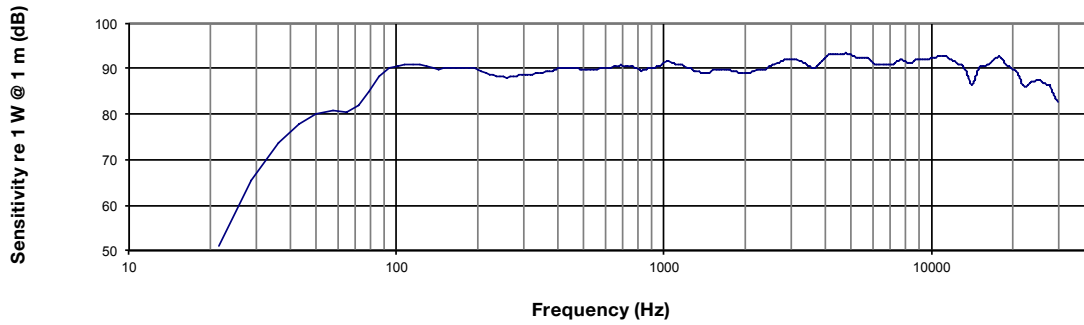

Anechoic Frequency Response

Impedance vs frequency

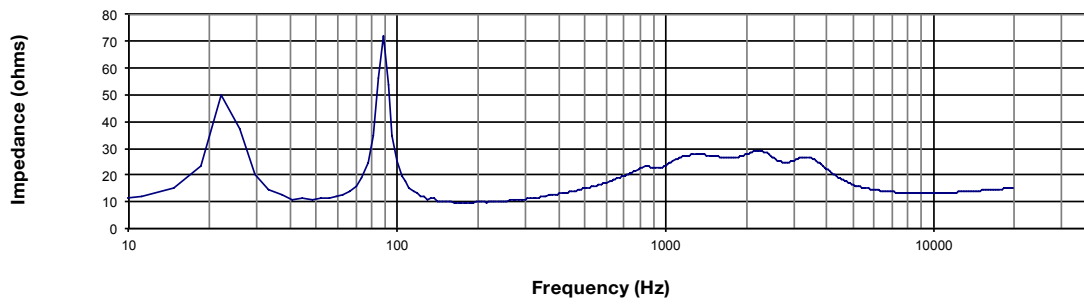

Impedance

Off-axis Frequency Response

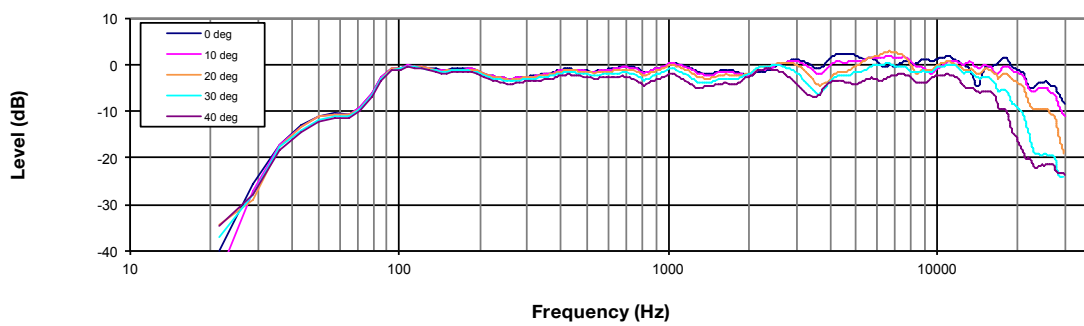

Off Axis Response

Beamwidth vs Frequency

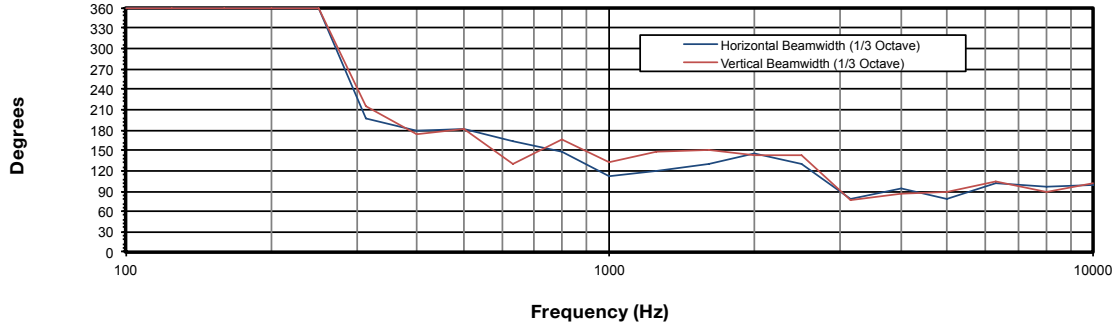

Beamwidth

Directivity Index (DI)

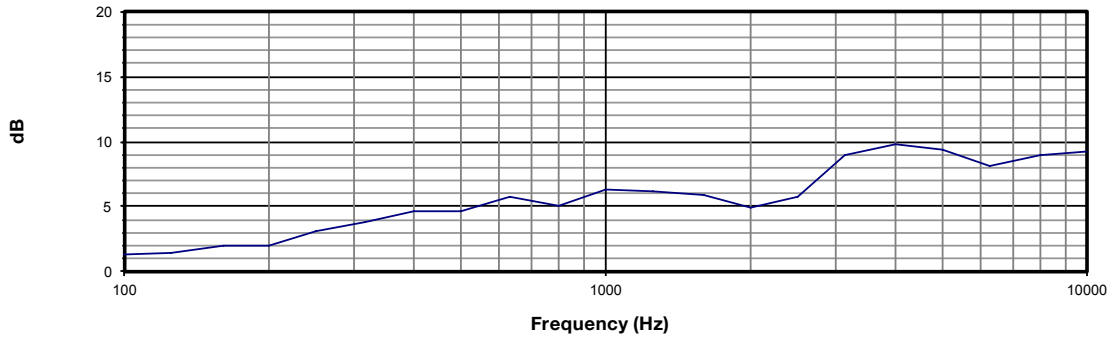

Directivity Index

Technical Data Sheet

Polar plots (1/3 octave)

AMS 8DC

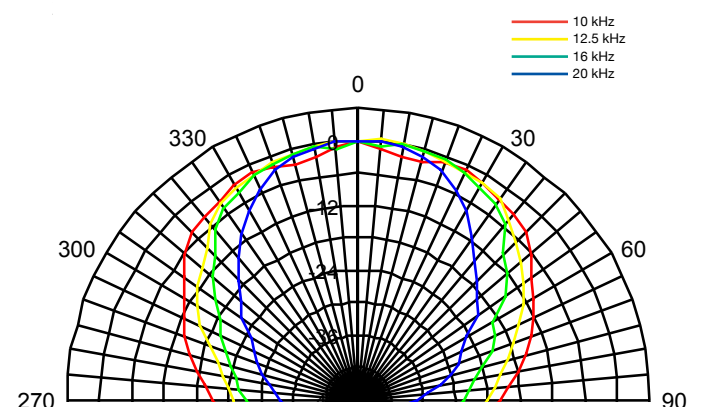
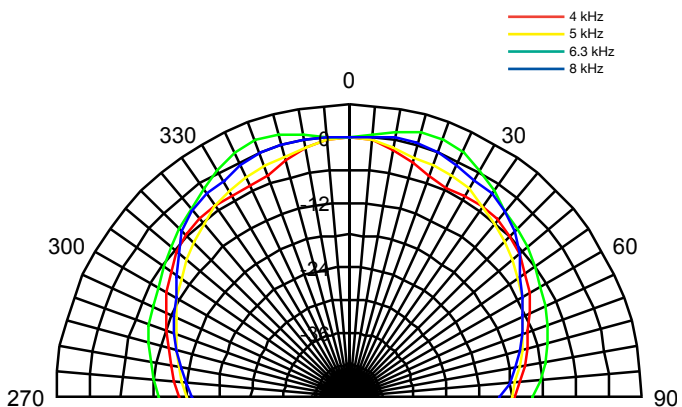
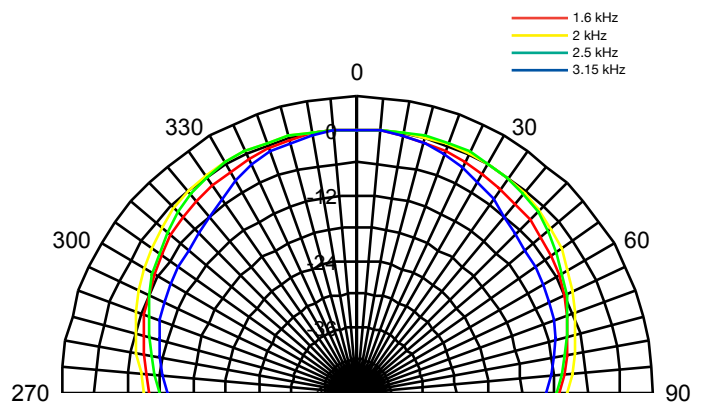
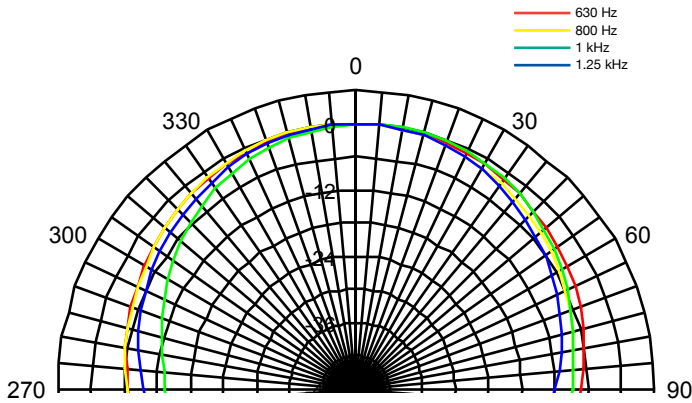
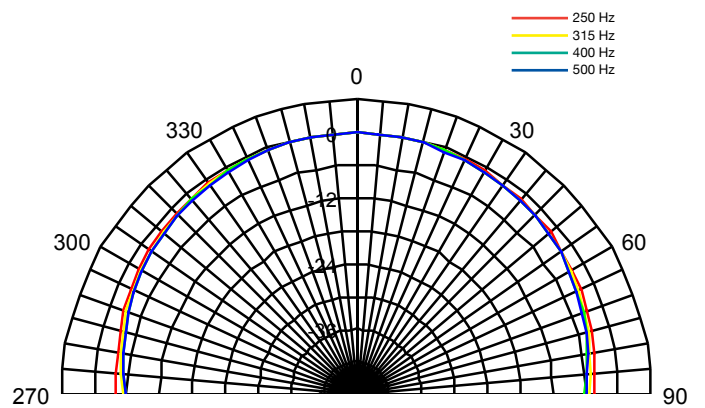
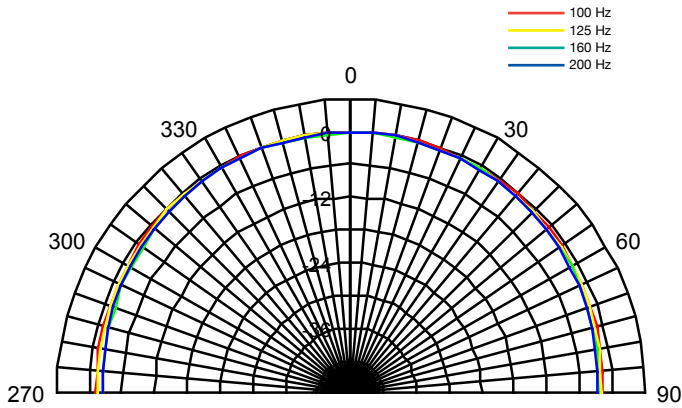

Technical Data Sheet

Specifications

AMS 8DC

Performance

System	AMS 8DC
Frequency response (-3 dB) ⁽¹⁾	65 Hz - 30 kHz
Frequency range (-10 dB) ⁽¹⁾	53 Hz - 40 kHz
System sensitivity (1 W @ 1m) ⁽²⁾	92 dB (1 W = 4 V for 16 ohms)
Nominal Coverage Angle	90 degrees conical
Power Handling ⁽³⁾	
Average	90 W
Programme	180 W
Peak	360 W
Recommended Amplifier Power	180 W @ 16 ohms
Nominal Impedance (Lo, Z)	16 ohms
Rated maximum SPL	
Average	111 dB
Peak	117 dB
Transformer Taps (via front rotary switch)	
70 V	60 W / 30 W / 15 W / 7.5 W / OFF & Low impedance operation
100 V	60 W / 30 W / 15 W / OFF & Low impedance operation

Transducers

Dual Concentric™ point source driver	1x 200 mm (8.00") Dual Concentric™ driver, using Omnimagnet technology
Low Frequency	44 mm (1.75") voice coil, treated multi fibre paper pulp cone
High Frequency	25 mm (1.00") PEI dome

Physical

Enclosure	ABS
Grille	Steel, plated and painted
Connectors	Removable locking connector with screw terminals
Transformer setting	Rotary switch
Dimensions (H x W x D)	409.8 x 260.0 x 306.3 mm (16.13 x 10.24 x 12.06")
Net Weight (ea)	7.82 kg (17.24 lbs)
Shipped weight	8.69 kg (19.16 lbs)
Included Accessories	Yoke bracket
Packed Quantity	2

Ordering Information

Part Number	Colour
8001 7990	Black
8001 7791	White



Notes:

1. Average over stated bandwidth. Measured in an IEC baffle in an Anechoic Chamber
2. Unweighted pink noise input, measured at 1 metre on axis
3. Long term power handling capacity as defined in EIA - 426B test

A full range of measurements, performance data, CLF and Ease™ Data for AMS 8DC can be downloaded from www.tannoypro.com.

Tannoy operates a policy of continuous research and development. The introduction of new materials or manufacturing methods will always equal or exceed the publishing specifications, which Tannoy reserves the right to alter without prior notice. Please verify the latest specifications when dealing with critical applications.

Copyright (c) 2015 Tannoy Limited. All rights reserved.

