



Product Description

The high power handling Definition Install DC12i has been designed around the unique Tannoy Dual Concentric™ drive unit to bring audiophile performance to a wide range of installation applications; from media rooms to home theatre and boardrooms through to high end marine interiors these loudspeakers deliver class leading accuracy, sensitivity and dynamics.

Characteristic of the Dual Concentric™ design is a very wide 'sweet spot' with an exceptionally even response throughout the listening area, as well as an extraordinary transient response; reasons enough for this phase accurate Tannoy designed drive unit to have been the choice of professional studio engineers all over the world for many years.

The Dual Concentric™ is effectively two drivers properly merged into one where, unlike ordinary drive units, the high frequency unit is positioned on the back of the low frequency driver. As a result they are on same axis, so ensuring that sound energy is effectively propagated from the same point and delivered through the centre of the low frequency cone as true point source. Such integration optimises reproduction quality by providing a constant time delay over the frequency spectrum, exceptional transient performance, wide dispersion and superior harmonic alignment; all of which delivers to the listening position a natural, clean and integrated sound with greatly enhanced intelligibility, sound staging and dynamics.

This compact MDF cabinet is vented and rigidly constructed with extensive bracing to be acoustically inert. The speaker is designed to be hidden within a custom designed installation; mounted on wall either behind the screen or acoustically transparent decorative panels with no appreciable loss of performance. The unit can be mounted either horizontally or vertically using the integral keyhole mounts and the supplied wall plate. Designed to be used in left, centre or right locations the high power handling DC12i and at 97dB (1W = 2.83V for 8 Ohms) is exceptionally sensitive and therefore capable of very high output levels, explosive dynamics and stunning detail in both music and movie applications in vast array of listening and viewing environments

Features

- 300mm (12.00") high sensitivity, point source and constant directivity Dual Concentric™ drive unit
- Constant time delay over the frequency spectrum
- Exceptional transient performance
- 90 degree conical dispersion
- Superior harmonic alignment
- Natural, clean and integrated sound
- Enhanced intelligibility, sound staging and dynamics
- Recommended amplifier power 100 to 400W @ 8 Ohms
- Sensitivity 97dB (1W = 2.83V for 8 Ohms)
- Maximum SPL 126dB average
- Rugged construction MDF enclosure, vented, internally braced and finished with textured black paint
- Multiple hanging options

Applications

- Media rooms
- Home theatre
- Boardrooms
- High end marine interiors

Tannoy United Kingdom
Tannoy North America
Tannoy Deutschland
Tannoy France

T: 00 44 (0) 1236 420199
T: 00 1 (519) 745 1158
T: 00 49 (180) 1111 881
T: 00 33 (0)1 7036 7473

E: enquiries@tannoy.com
E: inquiries@tannoyna.com
anfragen@tannoy.com
E: ventes@tannoy.com

tannoy.com



Definition Install DC12i

TANNOY®

TECHNICAL SPECIFICATIONS

System	Definition Install DC12i	
Frequency Range ⁽¹⁾	50Hz - 38kHz	
System Sensitivity (1W @1m) ⁽²⁾	97dB (1W = 2.83V for 8 Ohms)	
Dispersion (-6dB)	90 degrees conical	
Driver Complement	1 x 300mm (12.00") point source constant directivity Dual Concentric™	
Crossover	Passive 1.4kHz with dynamic HF protection	
Directivity Factor (Q)	6.0 averaged 1kHz to 10kHz	
Directivity Index (DI)	7.4 averaged 1kHz to 10kHz	
Rated Maximum SPL ⁽²⁾		
Average	120dB	
Peak	126dB	
Power Handling		
Average	200W	
Programme	400W	
Peak	800W	
Recommended Amplifier Power	400W @ 8 Ohms	
Nominal Impedance	8 Ohms	
Distortion		
10% Full Power (12.65V)	2nd Harmonic	3rd Harmonic
250Hz	0.53%	0.35%
1kHz	2.36%	1.88%
10kHz	2.68%	0.16%
1% Full Power (4.00V)	2nd Harmonic	3rd Harmonic
250Hz	0.17%	0.09%
1kHz	0.52%	0.99%
10kHz	0.96%	0.02%

Notes:

- (1) Average over stated bandwidth. Measured at 1 metre on axis.
- (2) Unweighted pink noise input, measured at 1 metre in an anechoic chamber

A full range of measurements, performance data, CLF and Ease™ Data can be downloaded from www.tannoy.com

Full independent verification of published specifications carried out by NWA Labs, California can also be obtained from the downloads section of www.tannoy.com

Tannoy operates a policy of continuous research and development. The introduction of new materials or manufacturing methods will always equal or exceed the published specifications, which Tannoy reserves the right to alter without prior notice. Please verify the latest specifications when dealing with critical applications.

Construction	
Enclosure	MDF, vented and internally braced
Finish	Textured black paint
Connectors	2 x 4mm gold plated binding posts
Fittings	8 x M10 bracket inserts, 4 wall plate keyhole fixings, allowing landscape or portrait mounting orientations 1 x wall plate
Dimensions	550 x 410 x 255mm (H x W x D) (21.65 x 16.14 x 10.04") (H x W x D)
NET Weight	20kg (44 lbs)

Ordering Information

PART NUMBER	MODEL NAME	COLOUR	PACKED QUANTITY
8000 5190	Definition Install DC12i	Black	1

Tannoy United Kingdom
Tannoy North America
Tannoy Deutschland
Tannoy France

T: 00 44 (0) 1236 420199
T: 00 1 (519) 745 1158
T: 00 49 (180) 1111 881
T: 00 33 (0)1 7036 7473

E: enquiries@tannoy.com
E: inquiries@tannoyna.com
E: anfragen@tannoy.com
E: ventes@tannoy.com

tannoy®.com



Definition Install DC12i

TANNOY®

PERFORMANCE MEASUREMENTS

1m on-axis frequency response

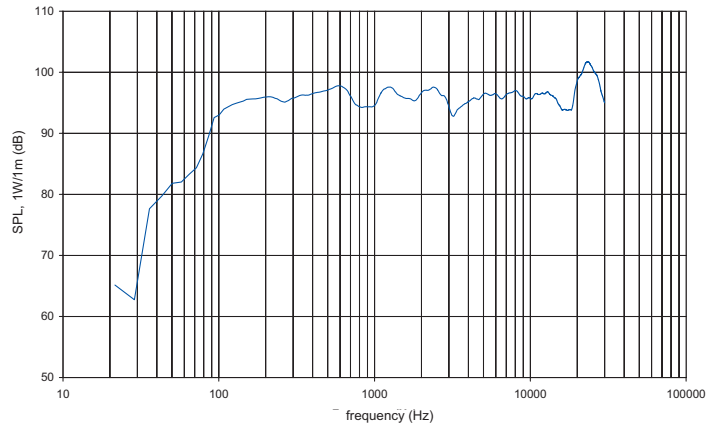

ANECHOIC
FREQUENCY
RESPONSE

Impedance vs frequency

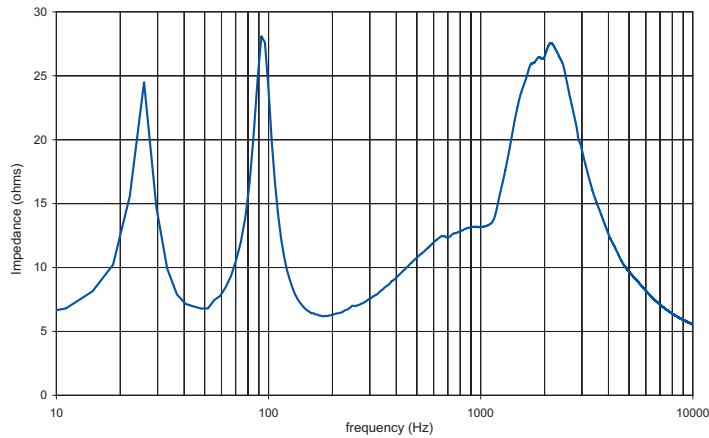

IMPEDANCE

Horizontal off-axis response

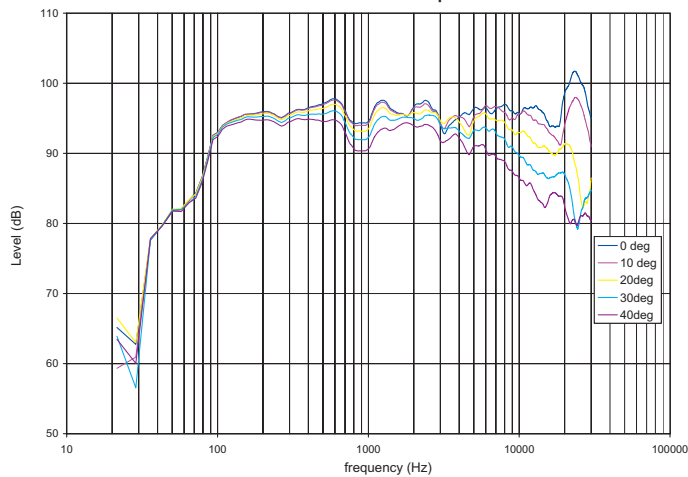

OFF AXIS
RESPONSE

Tannoy United Kingdom
 Tannoy North America
 Tannoy Deutschland
 Tannoy France

T: 00 44 (0) 1236 420199
 T: 00 1 (519) 745 1158
 T: 00 49 (180) 1111 881
 T: 00 33 (0)1 7036 7473

E: enquiries@tannoy.com
 E: inquiries@tannoyna.com
 anfragen@tannoy.com
 E: ventes@tannoy.com

tannoy®.com



Definition Install DC12i

TANNOY®

PERFORMANCE MEASUREMENTS

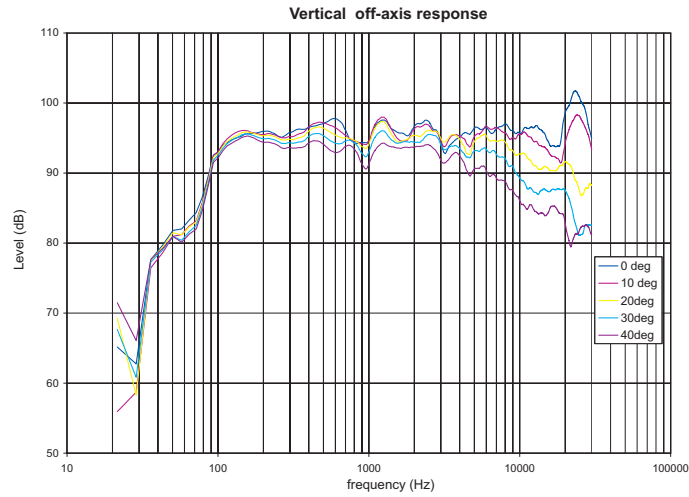

OFF AXIS RESPONSE

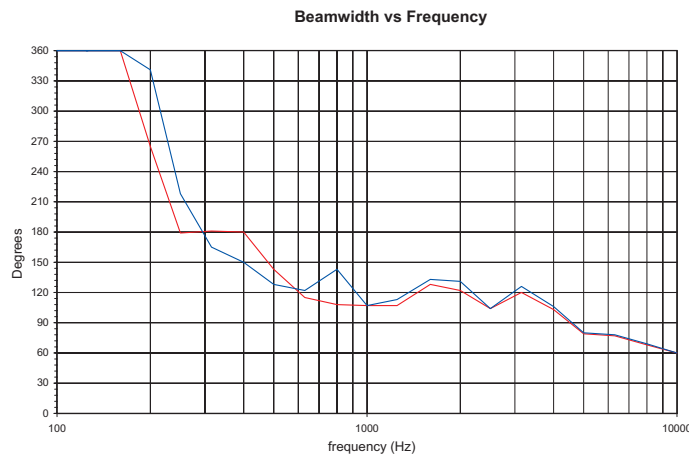

BEAMWIDTH

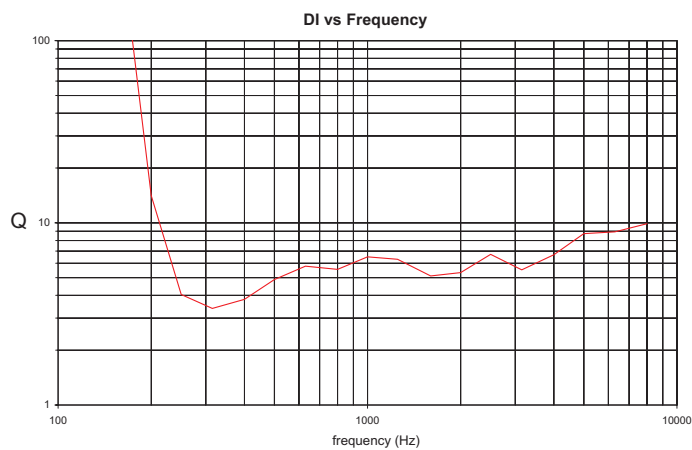

DIRECTIVITY INDEX

Tannoy United Kingdom
 Tannoy North America
 Tannoy Deutschland
 Tannoy France

T: 00 44 (0) 1236 420199
 T: 00 1 (519) 745 1158
 T: 00 49 (180) 1111 881
 T: 00 33 (0)1 7036 7473

E: enquiries@tannoy.com
 E: inquiries@tannoyna.com
 anfragen@tannoy.com
 E: ventes@tannoy.com

tannoy®.com



Definition Install DC12i

TANNOY®

PERFORMANCE MEASUREMENTS POLAR PLOTS (1/3 OCTAVE)

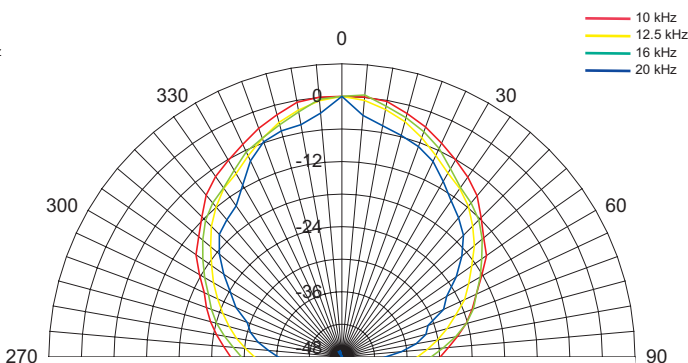
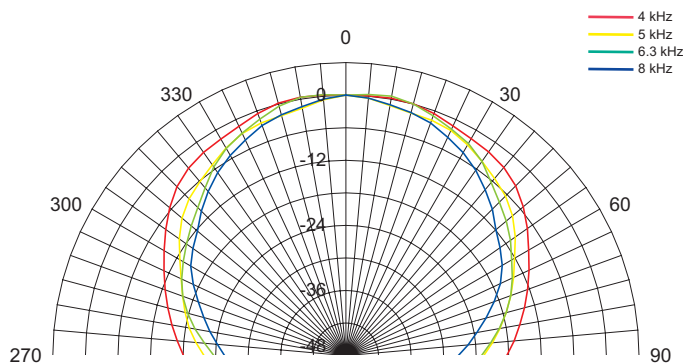
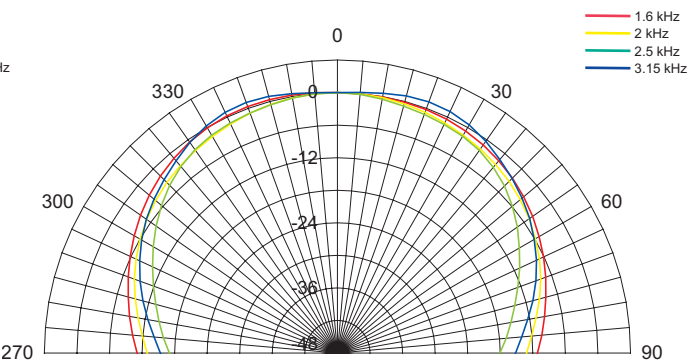
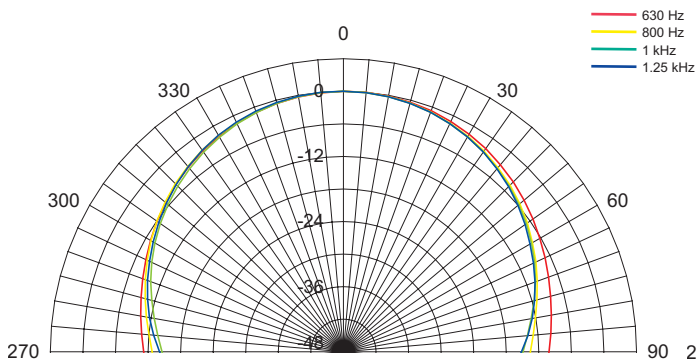
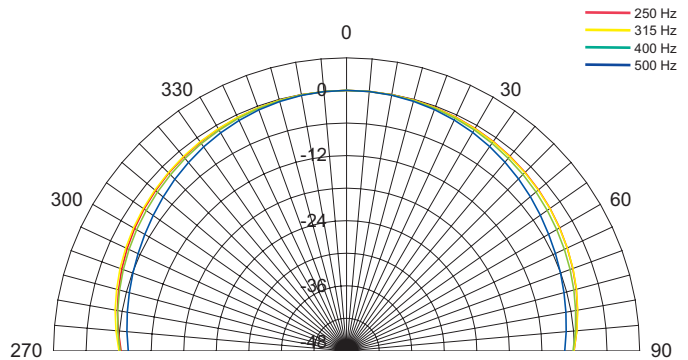
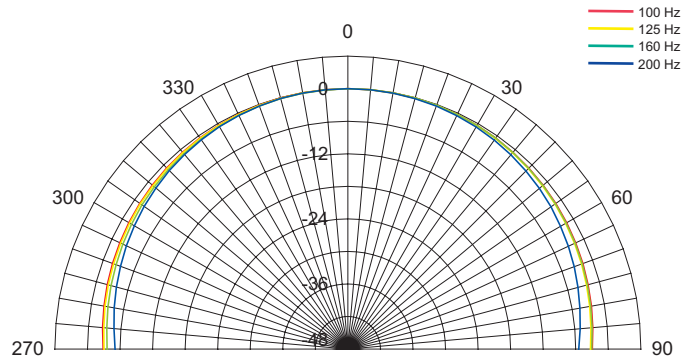

Tannoy United Kingdom
 Tannoy North America
 Tannoy Deutschland
 Tannoy France

T: 00 44 (0) 1236 420199
 T: 00 1 (519) 745 1158
 T: 00 49 (180) 1111 881
 T: 00 33 (0)1 7036 7473

E: enquiries@tannoy.com
 E: inquiries@tannoyna.com
 anfragen@tannoy.com
 E: ventes@tannoy.com

tannoy®.com



Definition Install DC12i

TANNOY®

PERFORMANCE MEASUREMENTS POLAR PLOTS (1/3 OCTAVE)

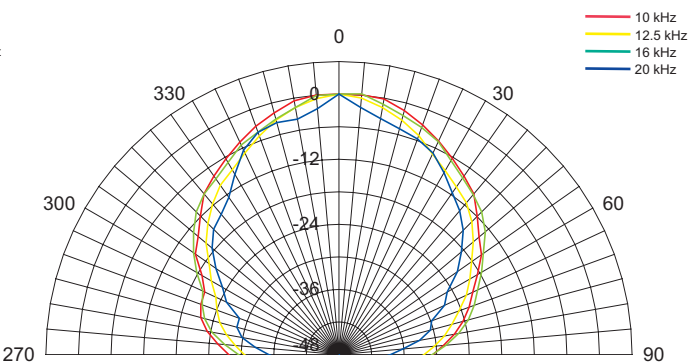
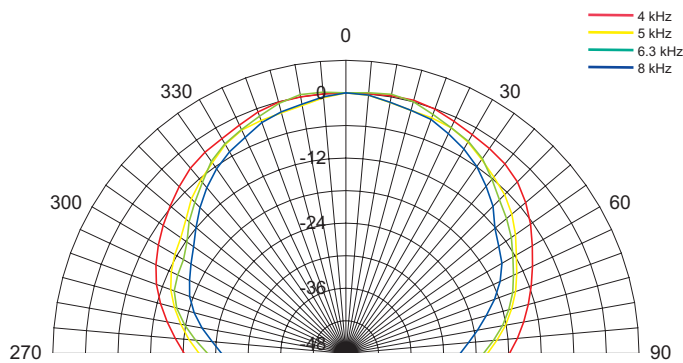
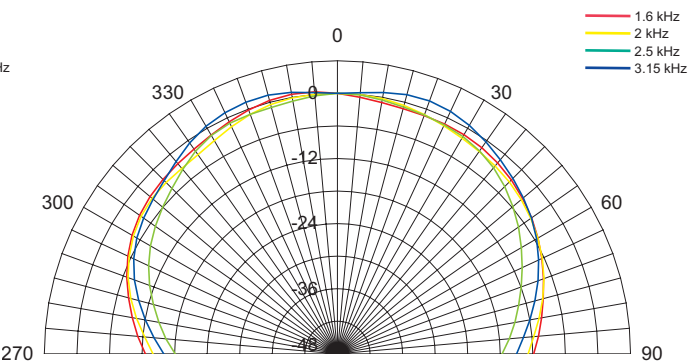
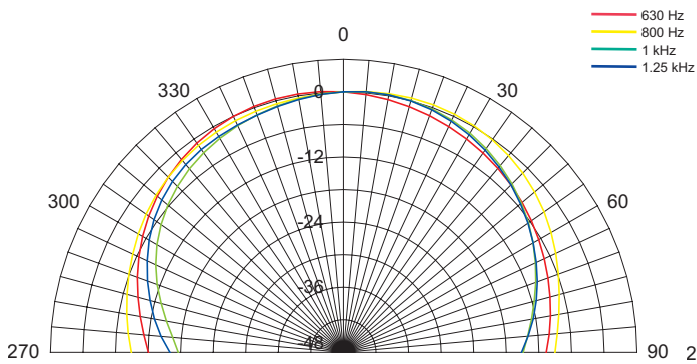
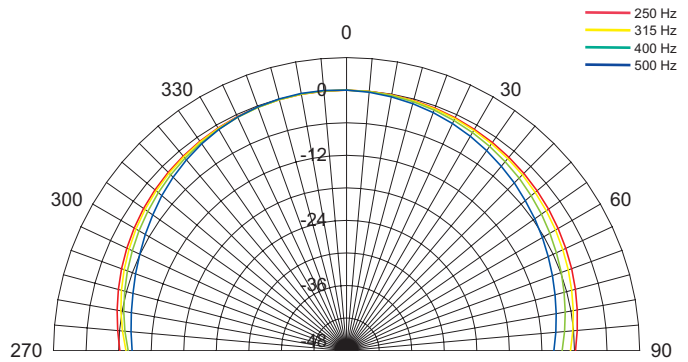
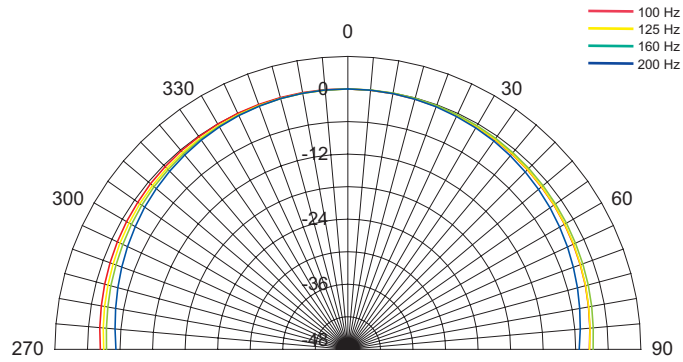

Tannoy United Kingdom
 Tannoy North America
 Tannoy Deutschland
 Tannoy France

T: 00 44 (0) 1236 420199
 T: 00 1 (519) 745 1158
 T: 00 49 (180) 1111 881
 T: 00 33 (0)1 7036 7473

E: enquiries@tannoy.com
 E: inquiries@tannoyna.com
 anfragen@tannoy.com
 E: ventes@tannoy.com

tannoy.com



DIMENSIONAL SKETCHES

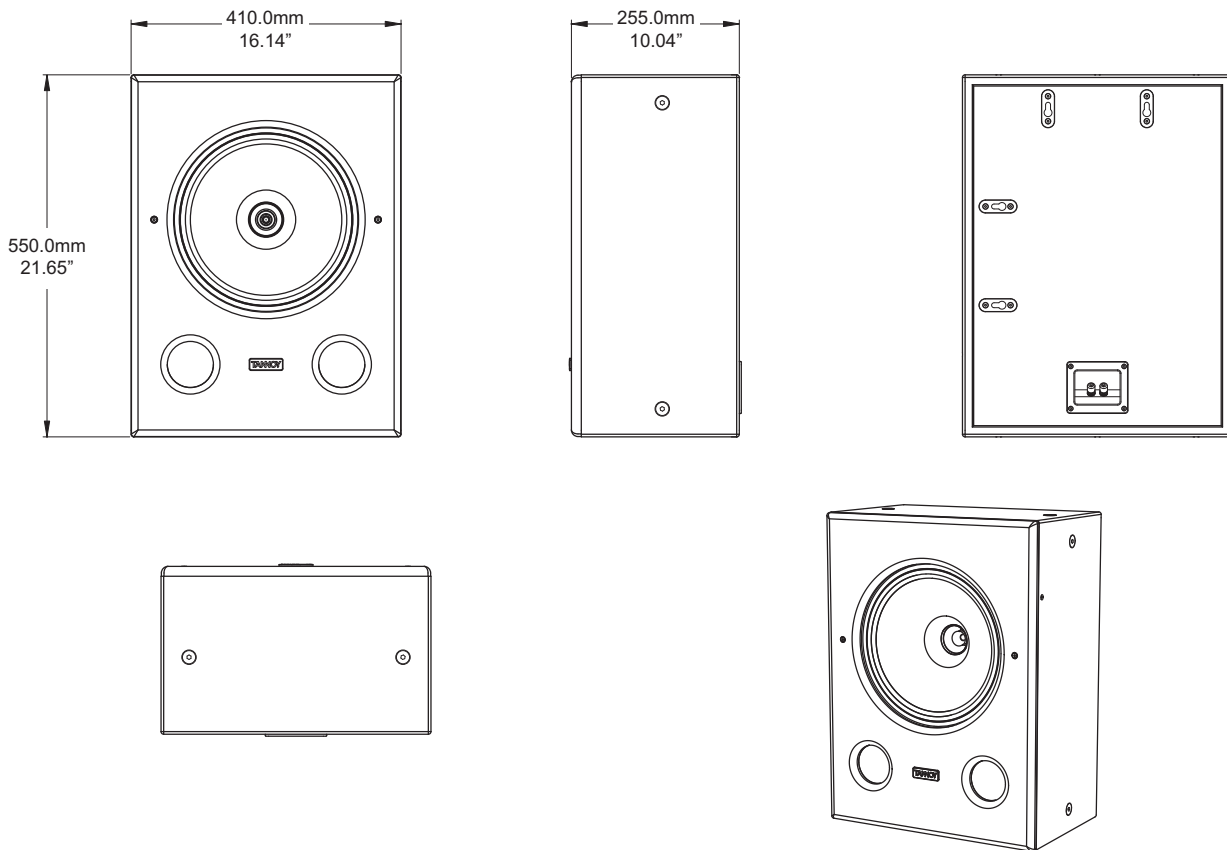

SUPPLIED WALL MOUNTING PLATE

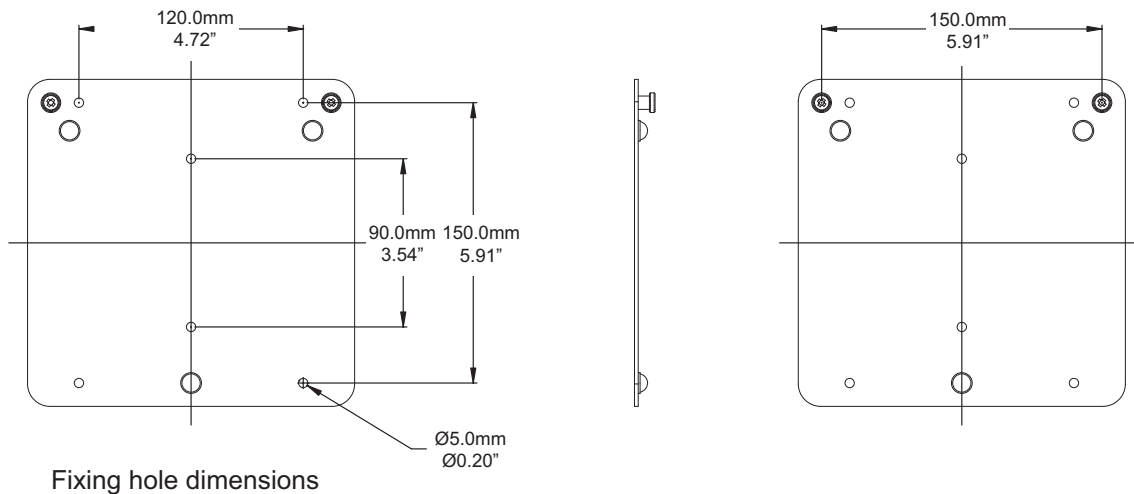

Tannoy United Kingdom
Tannoy North America
Tannoy Deutschland
Tannoy France

T: 00 44 (0) 1236 420199
T: 00 1 (519) 745 1158
T: 00 49 (180) 1111 881
T: 00 33 (0)1 7036 7473

E: enquiries@tannoy.com
E: inquiries@tannoyna.com
anfragen@tannoy.com
E: ventes@tannoy.com

tannoy.com



Architectural specifications

The loudspeaker shall consist of a 300mm (12.00") full range, point source Dual Concentric™ transducer. The low and high frequency elements shall be combined by an internal passive crossover network operating at 1.4kHz with dynamic HF protection.

Performance of the loudspeaker, without any electronic control, shall meet or exceed the following criteria: Frequency range measured at 1 metre on axis with swept sine wave shall be 50Hz to 38kHz. Sensitivity shall be at least 97dB (anechoic) for 2.83 Volts @ 1 metre and shall be capable of producing a peak output level of 126dB (anechoic) on axis at 1 metre. The dispersion of the loudspeaker shall be 90 degrees conical (-6dB). The system shall have a nominal impedance of 8 Ohms and maximum power handling shall be 400 Watts (programme).

The enclosure shall be an optimally tuned 39.50 litre vented cabinet of MDF construction. Connectors shall be 2 x 4mm binding posts. The enclosure shall be fitted with 8 x integral M10 bracket inserts and 4 x keyhole fixings for portrait or landscape mounting using supplied wall plate.

The enclosure shall not exceed the following dimensions: 550 x 410 x 255mm (21.65 x 16.14 x 10.04") (H x W x D).

The loudspeaker shall be the Tannoy... Definition Install DC12i.

Tannoy United Kingdom
Tannoy North America
Tannoy Deutschland
Tannoy France

T: 00 44 (0) 1236 420199
T: 00 1 (519) 745 1158
T: 00 49 (180) 1111 881
T: 00 33 (0)1 7036 7473

E: enquiries@tannoy.com
E: inquiries@tannoyna.com
anfragen@tannoy.com
E: ventes@tannoy.com

tannoy®.com